

Notice de pose

Store bateau tissu

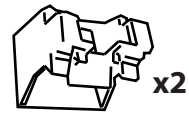

- 1** Marquez la position des supports dans le plafond ou la paroi.

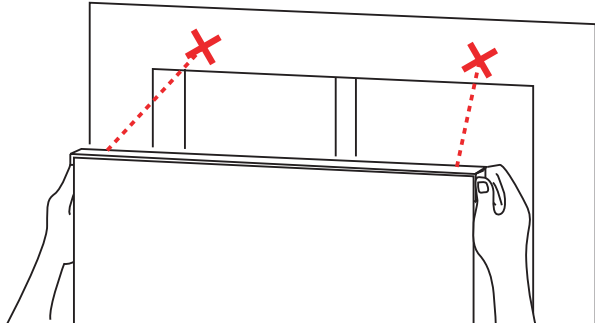

Fixation murale

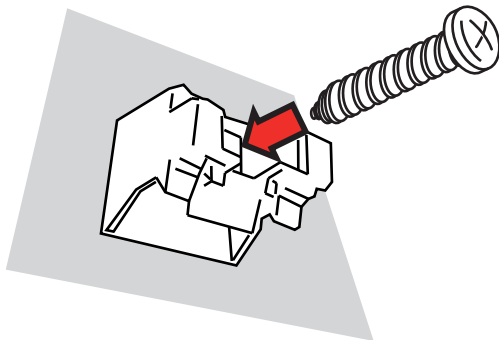

- 2** Faites un trou avec un foret et fixez les supports avec les vis.

Fixation plafond

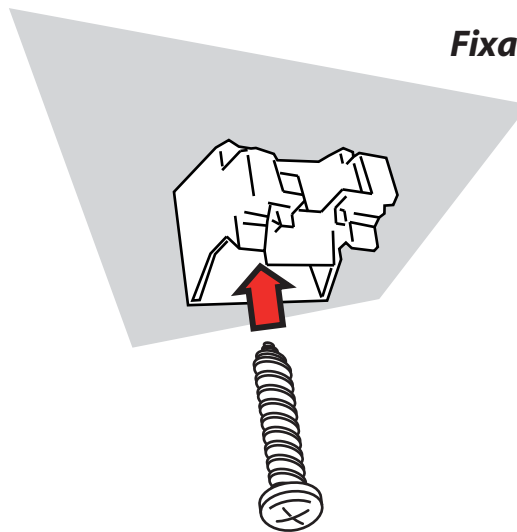

- 3** Clipsez la barre de charge du store sur les fixations.

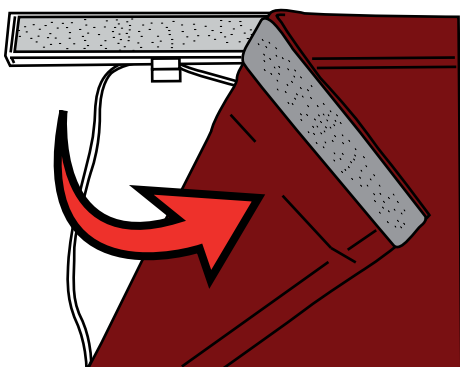

Toile détachable

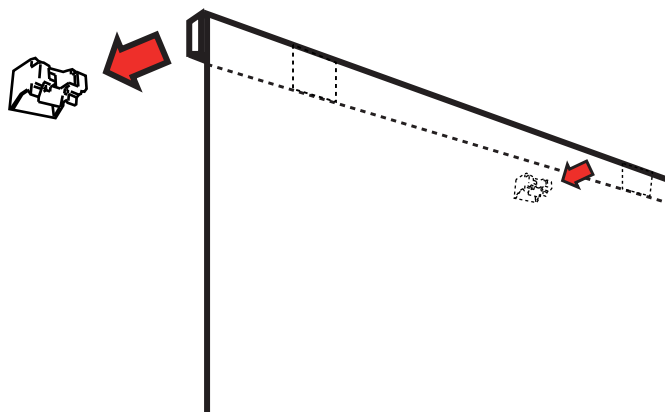

- 4** Félicitations, votre store bateau tissu est installé.

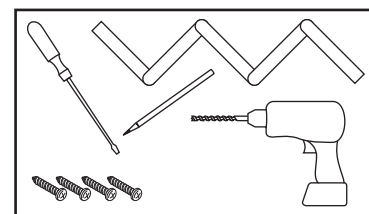

Vos outils et vos pièces